

sirah.com

Sirah
Lasertechnik



Pulsed Dye Lasers

Resonator Design: Mechanics

Reliability is inherent in the laser system design. All oscillator components are mounted on a solid block of low expansion stainless steel, mechanically and thermally isolated from outer laser housing. This construction removes virtually all mechanical and thermal stress from the oscillator block. To achieve best results we have developed a new linear guiding mechanics, mounted under the resonator base plate.

The use of Swiss made stainless steel guiding components result in ultimate wavelength accuracy (20 pm) and long term stability. Custom design step motor drivers ensure easy and precise control of the laser wavelength.

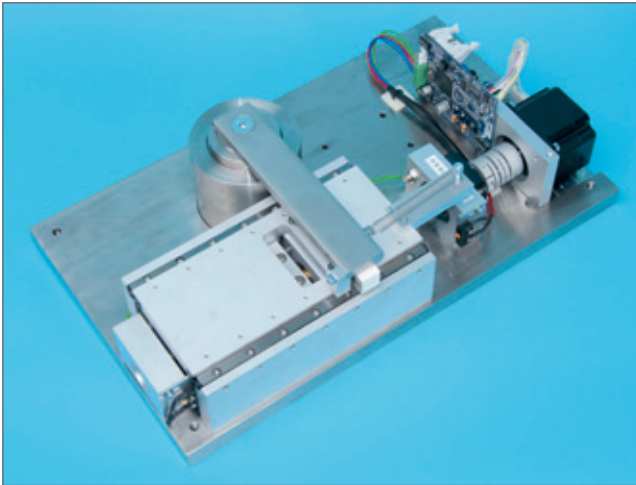

Resonator sine drive mechanics

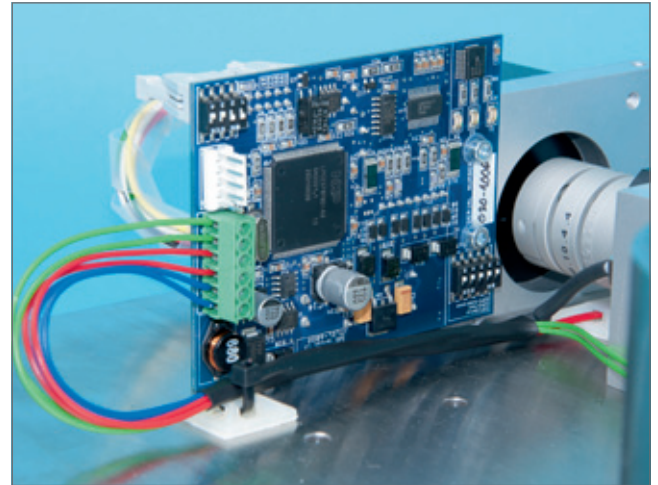

Electronic driver for stepper motor

Resonator Design: Optics

At the heart of the laser system is a grazing incidence resonator designed to utilize the grating's dispersion twice per oscillator round-trip, ensuring narrow linewidths with low ASE and higher efficiencies. An optional second grating can be added to the resonator for ultra narrow linewidths below 0.03 cm^{-1} at 570 nm . Therewith narrow-line tuning over a broad tuning range without the need for intra-cavity etalon is possible, thus simplifying the measurement process without sacrificing performance.

By using opto-mechanics optimized for easy and reproducible operation, the dye laser's oscillator stage requires very limited user adjustment.

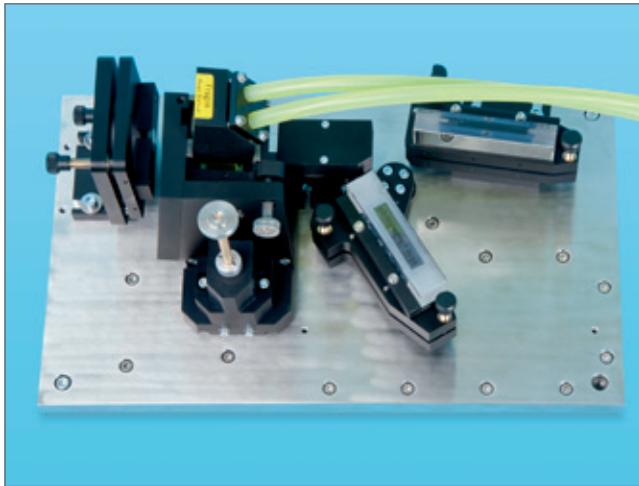

Double grating resonator; the resonator is built on a separate steel base.

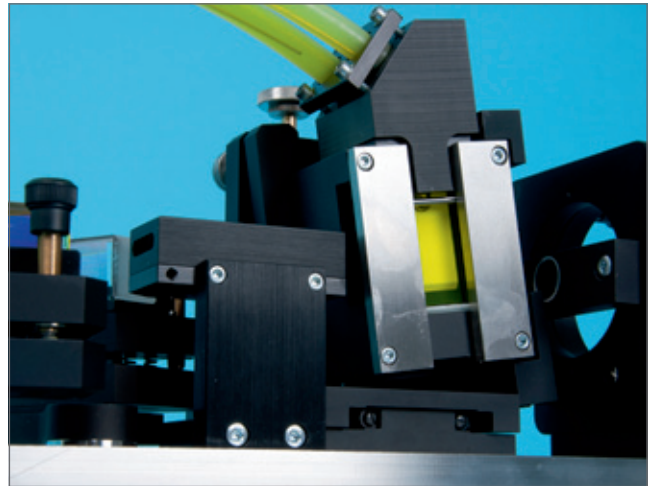

The dye cell's edges are protected by stainless steel sheets against burns from the pump laser pulses.

Grating Lift Option

The new resonator construction allows addition of a second grazing incidence gratings. Two gratings, each with a different line density are mounted and calibrated on a single linear stage that is activated by a button on the remote control. The grating lift option (patent pending) enables a single resonator to cover the entire tuning range of dye lasers without gaps due to

Wood's anomaly. No recalibration is necessary after changing from one grating to the other.

By choosing a 1800 l/mm grating and on the second position of the grating lift a 3000 l/mm grating, a tuning range from 370 - 920 nm is achieved with a better linewidth in the blue because of using the 3000 l/mm grating below 600 nm. This option eliminates all drawbacks of the grazing incidence resonator design.

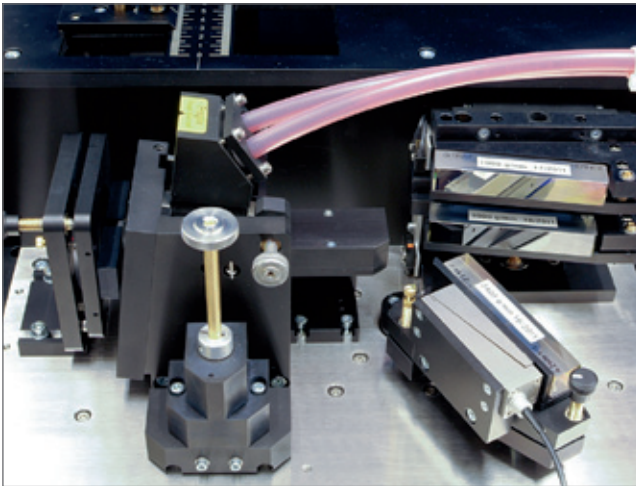

Resonator with grating lift, Littrow-Grating, and an additional piezoelectric actuator for rapid wavelength change.

Quick Change Dye Cuvettes

The laser's quartz dye cells are held in place by state-of-the-art mounts designed for stability and precision from high performance alloys and graphite-reinforced polymers. Hardened stainless steel sliding components force the cuvette assembly into exactly the same position with high reproducibility even after years of operation. The design enables extreme ease of use, the mounted cuvettes and the entire dye circulator unit can be removed in seconds without tools and without interrupting the dye flow loop.

This design is ideal for applications that require more than one type of dye. The quick change from one wavelength range to another saves time and eliminates the need for messy dye changes.

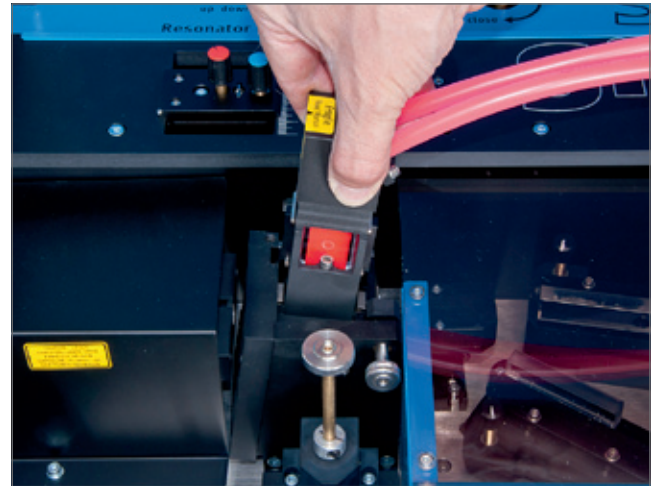

Cells are removable without tools.

Remote Control with Touch Screen

To allow operation from both sides of the laser all control buttons need to be flexible as well. Hence, lasers are equipped with a remote control. The control is connected by a 2 meter cable to a connector panel at the pump laser entrance side. The remote control gives access to detailed information on the laser status and supports extensive commands.



The most convenient and powerful control of the laser system is given by the software Sirah Control. It just requires a USB connection in between laser system and computer. Sirah provides a powerful LabVIEW interface for the lasers for the rapid integration of the dye lasers into any measurement environment.

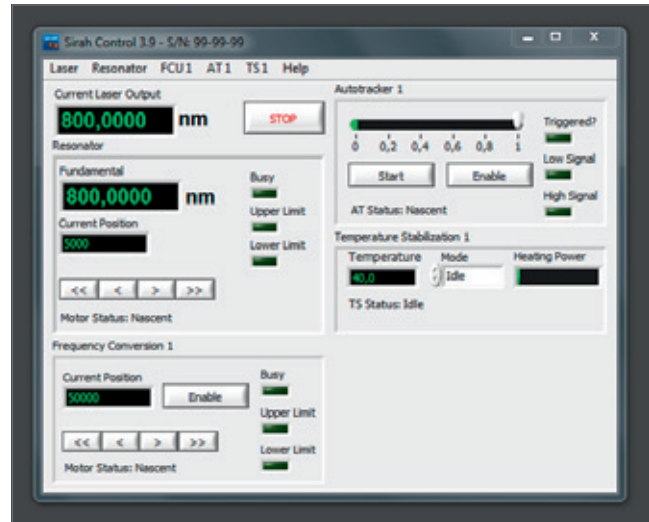

The lasers conform to industry communication standards, so it is possible to use them with a wide range of operating systems.

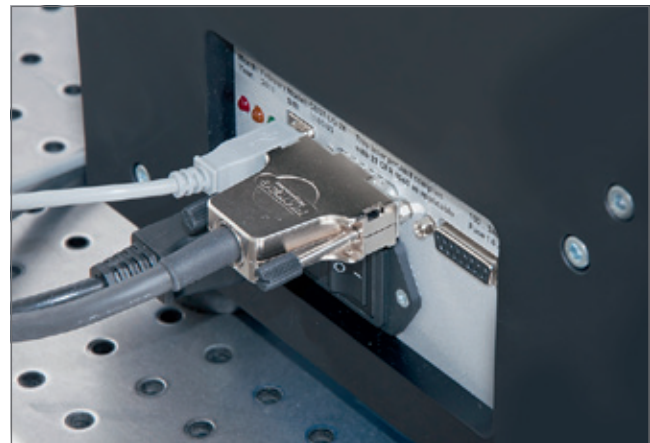

Quick Change Pump Optics

Fast and reproducible change between 532 nm and 355 nm pump wavelengths is achieved by using pre-aligned mechanics with two high power 180° steering mirror sets. These opto-mechanic assemblies fit exactly into holding fixtures inside the dye laser. Blue and green mirror sets have separate mechanic assemblies. So, complete assemblies are swapped without the need to handle the delicate mirrors directly.

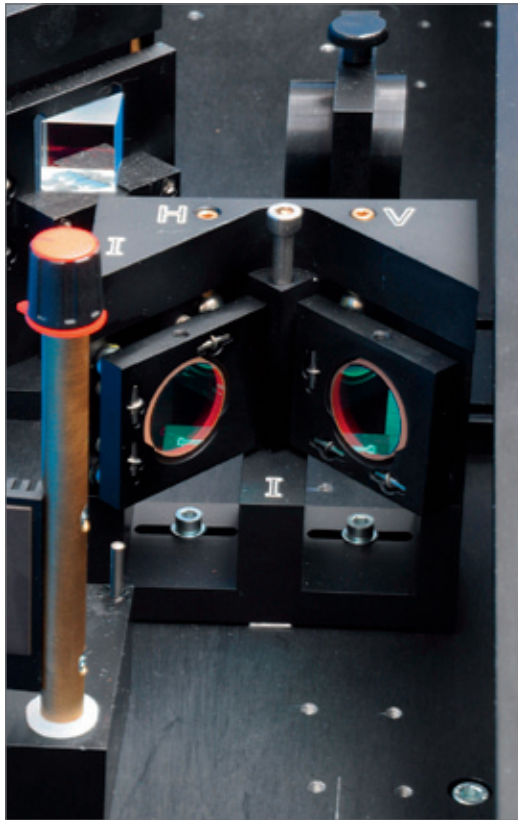

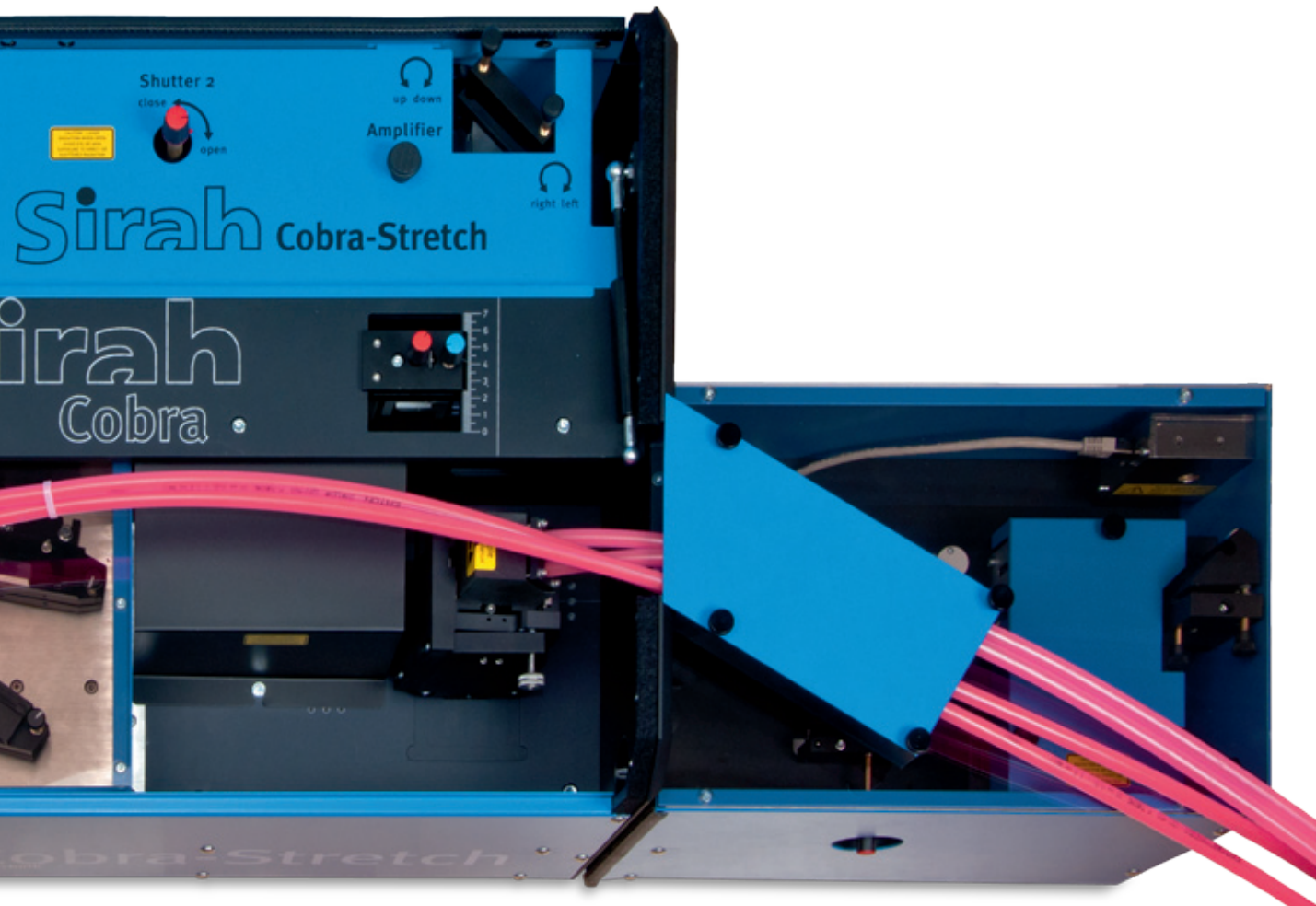

All adjustable components of the laser are handled from the top, making it possible to use the laser from both sides. Also, the lid is attachable to front and back of the laser's housing. This gives more freedom to integrate the laser into a table layout.

Smaller Footprint!

The new designed dye laser systems have smaller footprints saving more of your valuable table space.

Cobra-Stretch

Size 770 mm x 466 mm

Available with all different resonators (broadband, prisms, one or two gratings) with pre-amplification and one main amplifier stage. Main amplifier can be a large rectangle cell or one of our capillary cells with round beam pattern.

A non-linear optical conversion unit can be bolted to the exit side of the housing.

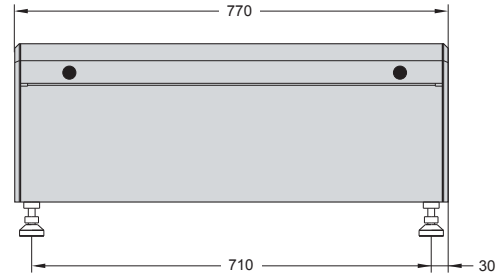

PrecisionScan

Size 1086 mm x 466 mm

Same like Cobra-Stetch but giving additional space to put doubling, separator and auto-tracking inside or a second amplifier stage, needed if pump energy is > 800 mJ.

A non-linear optical conversion unit can be bolted to the exit side of the housing.

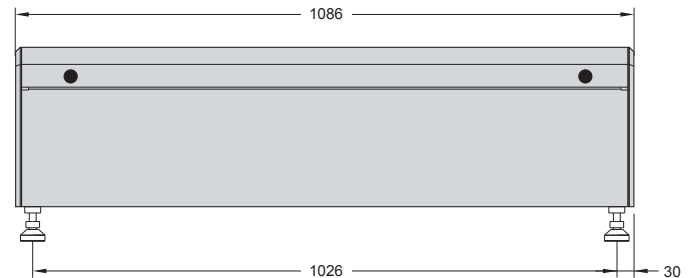

Frequency Conversion Unit (FCU)

Size 373 mm x 253 mm

An FCU can be placed inside a PrecisionScan or can be encased by an External Housing (FC-EXH). The External Housing needs to be bolted to a PrecisionScan or CobraStretch. Application is the doubling of the fundamental output from the dye laser. The External Housing can include compensator, wavelength separation and autotracking.

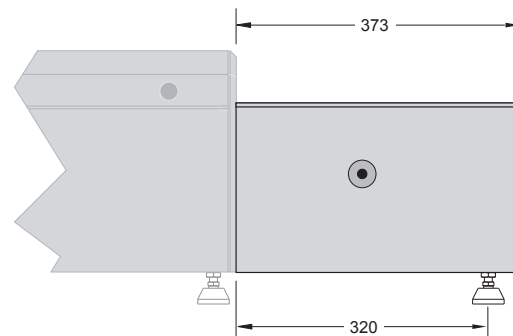

Stand Alone Housing (SAH)

Size 447 mm x 466 mm

Can be used for one stage non-linear processes like difference frequency mixing (DFM) or sum frequency mixing (SFM). Often this housing is used for the purpose of a stand alone autotracker.

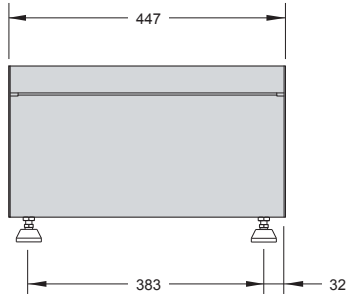

Tandem unit

Size 833 mm x 466 mm

Housing for two FCU's, two stage non-linear processes. Tripling of the dye (THU) is possible or mixing after doubling (MAD) or difference frequency mixing plus amplification (OPANIR)

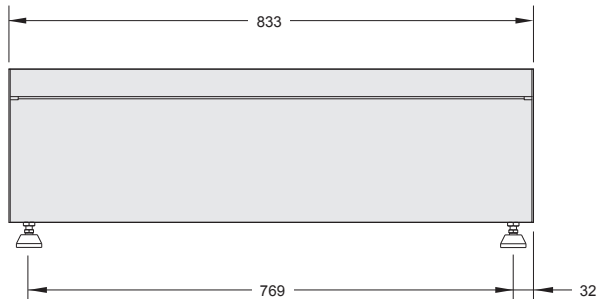

Covering the spectrum

The dye laser tuning range is easily extended to the UV and to the IR by non-linear conversion in different crystals. Also the good spectral and spatial quality of our laser beams ensure excellent conversion efficiency. With doubling (SHG) in long BBO crystals for example more than 15% conversion is easily achieved .

Doubling works down to approximately 205 nm, the limit for SHG in BBO. For wavelength under 205 nm more advanced non-linear processes like tripling, mixing after doubling or mixing range into the infrared difference frequency mixing is used. Sirah pioneered this technique and can provide a solution to your wavelength requirements. Please refer to our datasheets or contact us directly.

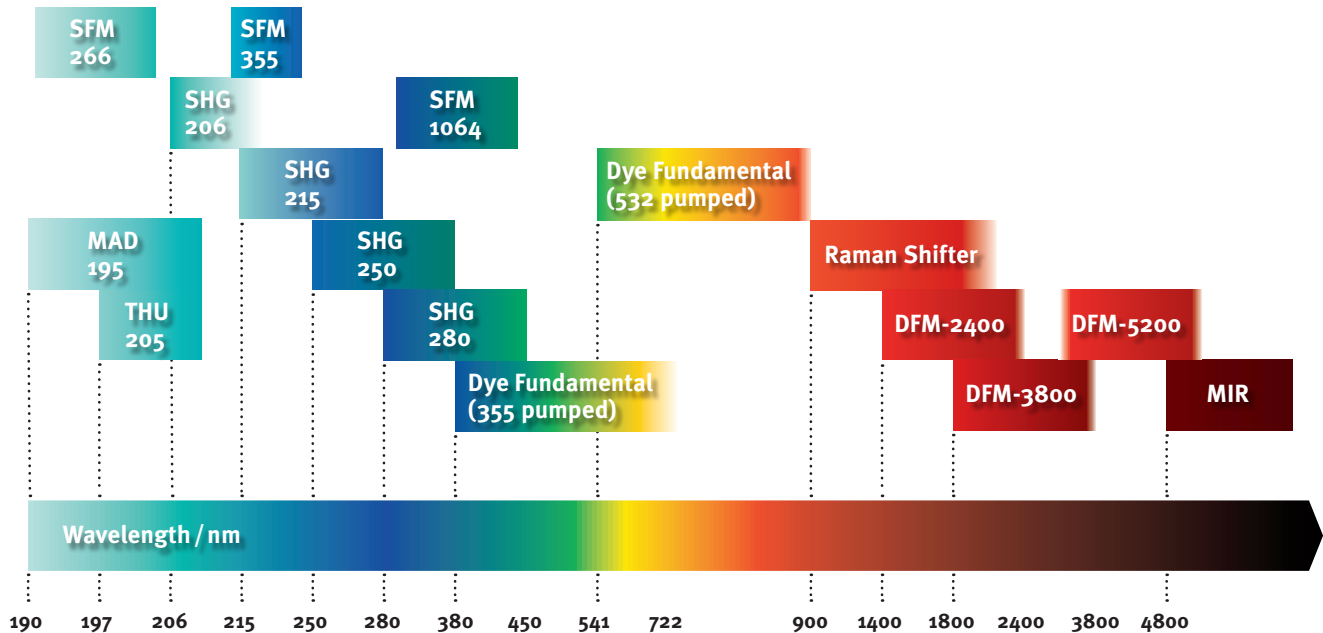

High Power Concept

Sirah is the only company offering a second amplifier for pump energy exceeding 800 mJ.

The pre-amplification takes place in a separate capillary cell with 4 mm inner diameter followed by the main amplifier that uses 6 mm capillary. The laser has a total of three circulators with three independent cells. This allows to use an optimized dye concentration for each of the stages. At the same time the pump energy is distributed over the stages, keeping the power level at each stage below damage threshold.

This scheme accommodates up to 1,500 mJ of 532 nm inside a PrecisionScan housing.

Furthermore, the use of two capillary cells in the amplifier stages supports an excellent beam profile at high dye laser pulse energies.

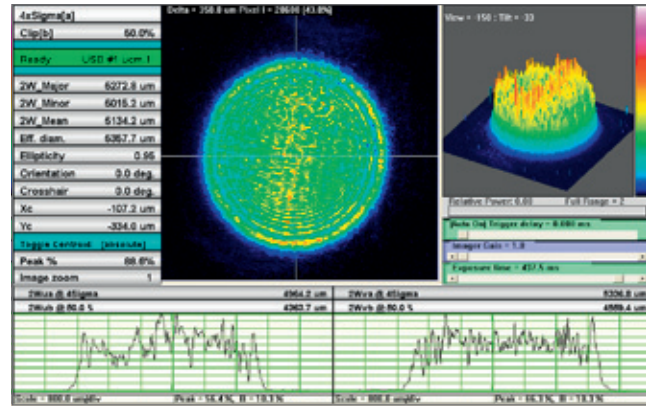

Nearfield

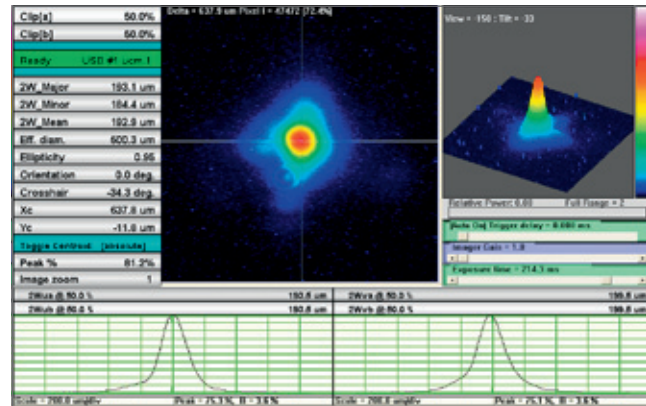

Farfield

Germany

Sirah · Lasertechnik GmbH

Heinrich-Hertz-Straße 11

D-41516 Grevenbroich

Phone+49 (2182) 82 98 18-0

Email info@sirah.com

United Kingdom

Photonic Solutions Ltd

Unit A, 40 Captains Road

Edinburgh EH17 8QF

Phone+44 (131) 664 8122

Email sales@photonicsolutions.co.uk

Worldwide

Newport Corporation * Spectra-Physics Lasers

3635 Peterson Way

Santa Clara, CA 95054

Phone+1 (408) 980-4300

Email sales@newport.com

